

THE PRIMO BOOK

# PRIMO MAKES IT EASY, FAST AND SAFE TO CHOOSE MOULDINGS

Finishmouldings  
Glazing bead  
Gaskets  
Wire & cable concealment  
Soft skirtings  
Stair nosings  
etc.

**PRIMO** 

[www.primolister.com/en/](http://www.primolister.com/en/)



## PLASTIC:

**Does not rot**

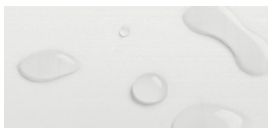

**Does not split**



**Does not break**



**Does not require painting**

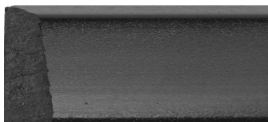

## WOOD:

Rotting...

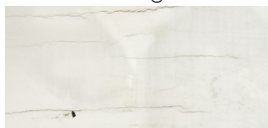

Splits...



Breaks...

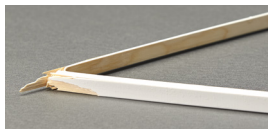

Requires painting...

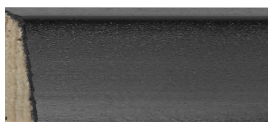

# GOOD REASONS TO CHOOSE PLASTIC MOULDINGS

All PRIMO mouldings are made from a durable and flexible plastic material. They easily follow the unevenness of the wall and are available in many variants.

The mouldings can be customised with incredible precision, professional result and with a minimum of waste. All you need are ordinary hand tools.

In addition, many of the mouldings have smart benefits, such as hiding cables and can be removed for wallpapering and painting. There is also a wide range of fittings, to ensure a beautiful result.

The mouldings are unaffected by moisture and therefore do not rot or discolour. This protects you against the development of harmful fungi and bacteria that create an unhealthy indoor climate.

PRIMO mouldings are ready to use when delivered, but can be painted if a different colour is desired.

Want to know more about PRIMO Denmark and our mouldings:

tel: +45 76 98 33 14

e-mail: [stdsalg@primo.dk](mailto:stdsalg@primo.dk)

or by visiting us at [www.primolister.com/en/](http://www.primolister.com/en/).

# WHAR COLOUR DO YOU WANT?



Black



Shiny black



Charcoal



Grey

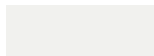

Light grey



White



Off-white



Alu



Anthracite



Slate



Merbau



Pine light



Beech



Ligh beech



Ash light



Oak



White oak



Oak Sonoma



Steel



Mørk oxid



Cherry



Mahogany



Granit

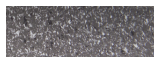

Stone

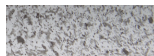

Stone light



Marble grey



Marble light



Marble



Walnut



Brown

# Table of context

Good reasons to choose plastic mouldings .....	<b>2-3</b>
What colour do you want? .....	<b>4</b>
Mouldings for your entire home .....	<b>6-7</b>
Self-adhesive mouldings .....	<b>8-9</b>
Finish mouldings .....	<b>10-11</b>
Angle- and corner profiles .....	<b>12-13</b>
Skirtings and architraves .....	<b>14-17</b>
Cable concealment .....	<b>18-21</b>
Wire-, cable- & pipe concealment .....	<b>22-23</b>
Kitchen mouldings .....	<b>24-25</b>
Wall - and edge mouldings .....	<b>26</b>
Glazing beads .....	<b>27-30</b>
Gaskets .....	<b>31-36</b>
Soft skirtings .....	<b>37-38</b>
Soft Angles .....	<b>39</b>
Various .....	<b>40-41</b>
Door and wall protection .....	<b>42</b>
Facades .....	<b>43</b>
Inventory .....	<b>44</b>

# Mouldings for your entire home

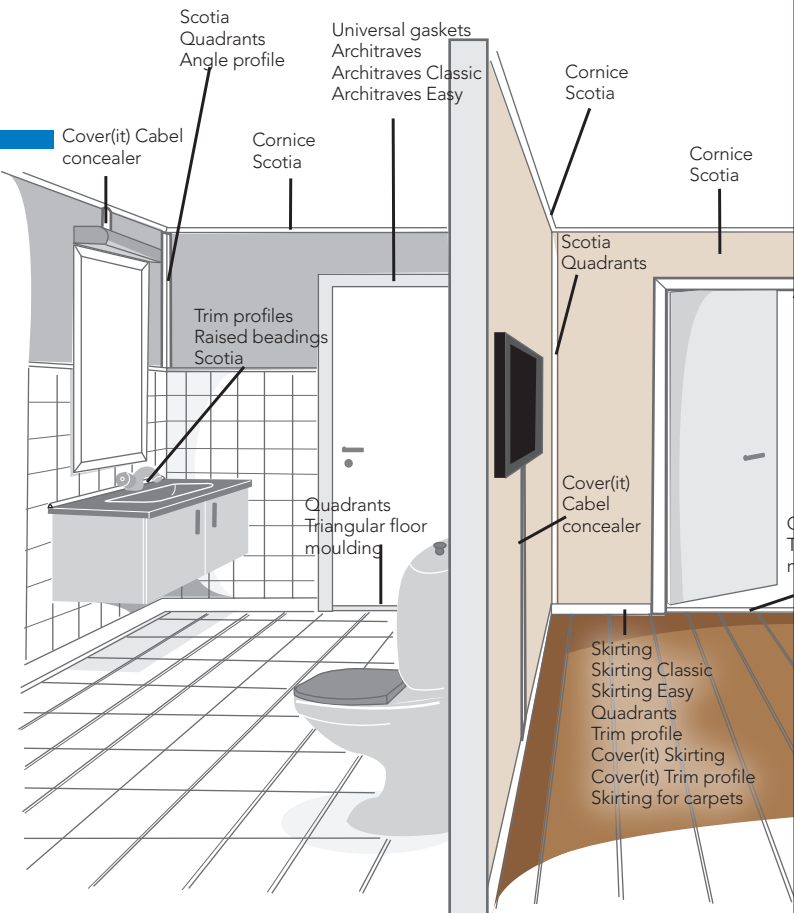

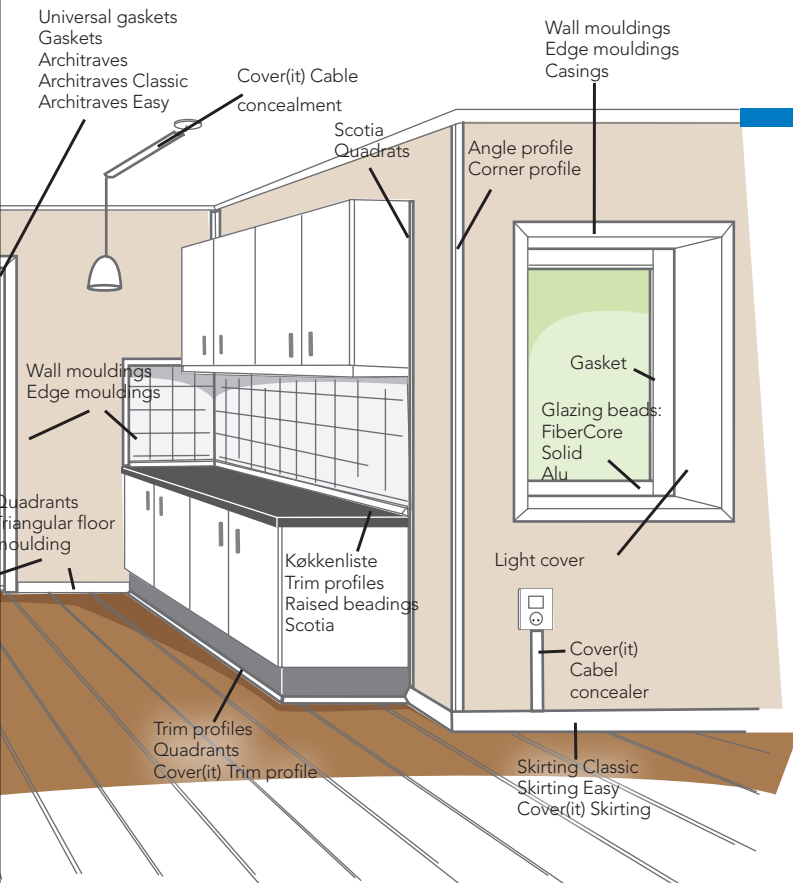

# SELF-ADHESIVE MOULDINGS



PRIMO is at the forefront of innovative solutions that fulfil the needs and wishes of the DIY enthusiast. With the new range of self-adhesive mouldings, developed in collaboration with professional craftsmen, installation tools are no longer needed and the path from an idea to renewal with a finished satisfactory result - is shortened.

Once the moulding is the right length, all you need to do is remove the protective film from the adhesive foil on the back and mount the moulding with a light pressure. The mouldings are delivered finished in white but, like the other mouldings in the PRIMOS range, can be painted in the colour of your choice.

## Trim profile

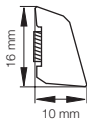

5001

## Quadrants

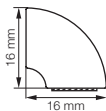

5115

## Scotia

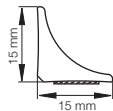

5110

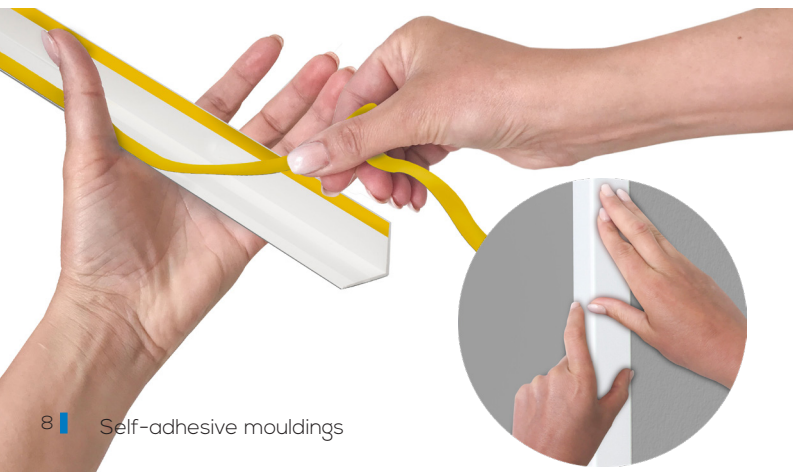



# SELF-ADHESIVE MOULDINGS

## Angle and corner profiles

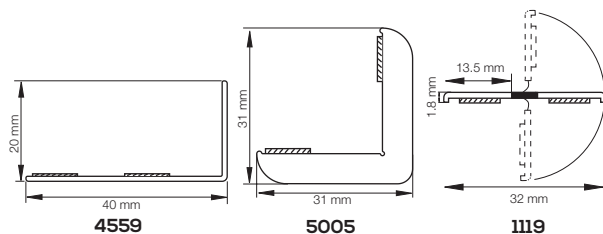
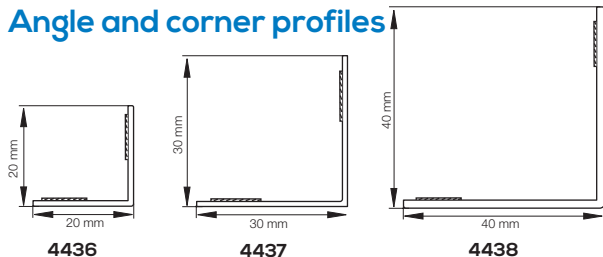

## Wall mouldings

## Edge mouldings

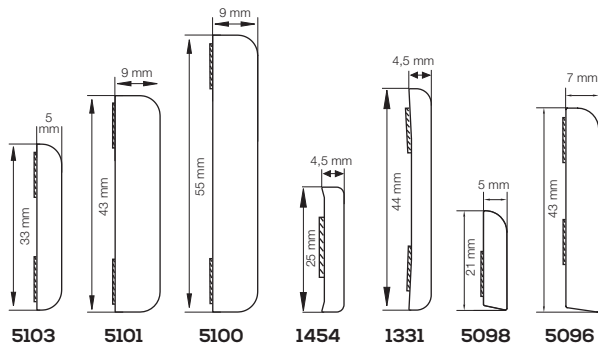

# FINISH MOULDINGS

## Trim profiles

### Colours:

**5001:** Black, grey, white, off-white, grey light, charcoal, beech, oak, alu, white oak, ash light, cherry, mahogany, pine light, merbau, anthracite, white (self-adhesive)

**1564:** Off-white

**5075:** Grey, white, grey light, off-white

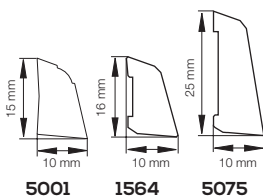

## Raised beadings

### Colours:

**5065:** Black, grey, white, off-white, beech, oak, grey light, alu, Ash light, cherry, charcoal,

**5073:** Grey, white, off-white, beech, black

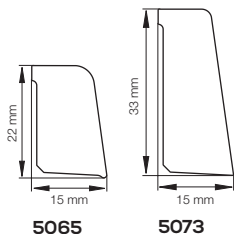

## Cornice

### Colours:

**5002:** White, off-white

**5074:** White

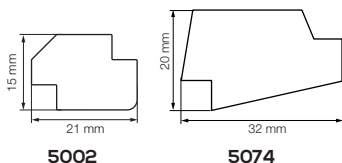

## Triangular floor profiles

### Colours:

**1511:** Beech, birch, white, oak

**7314:** Beech, oak

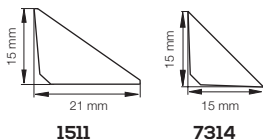

## Square glazing beads

Colours:

**5050, 7123:**

White

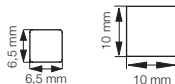

**5050**

**7123**

## Quadrants

Colours:

**5000:** White, beech, oak, grey

**5108:** White

**5115:** White, gry light, anthracite, off-white, white (self-adhesive)



**5000**



**5108**

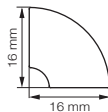

**5115**

## Scotia profiles

Colours:

**5110:** White, black, alu, white (self-adhesive)

**5078:** White, beech, alu

**5079:** White, beech, alu

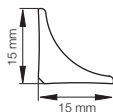

**5110**

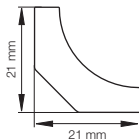

**5078**

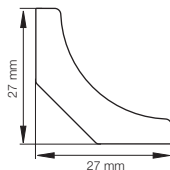

**5079**

# ANGLE- AND CORNER PROFILES

## Angle profiles

Colours:

**4434, 4435, 2069:** White

**4436, 4437, 4438:** White, white (self-adhesive)

**1604, 1273:** White

**1119:** White (self-adhesive)

**4559:** White, white (self-adhesive)

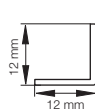

**4434**

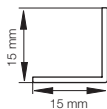

**4435**

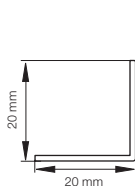

**4436**

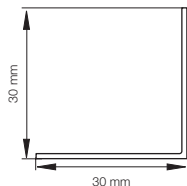

**4437**

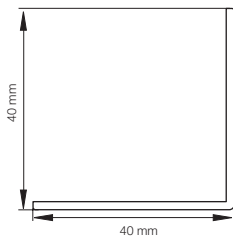

**4438**

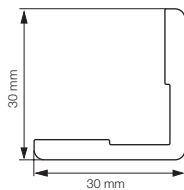

**1604**

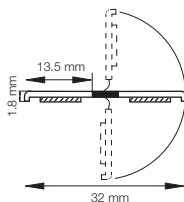

**1119**

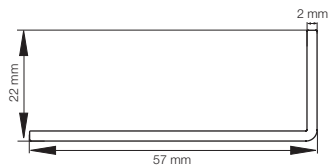

**1273**

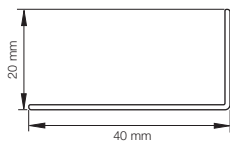

**4559**

## Corner profiles

Colours:

**5004:** White, oak

**5005:** White, oak, anthracite,  
white (self-adhesive)

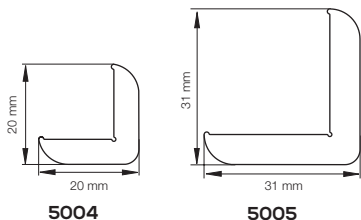

## Wallpaper angle

Colours:

**1576:** Off-white

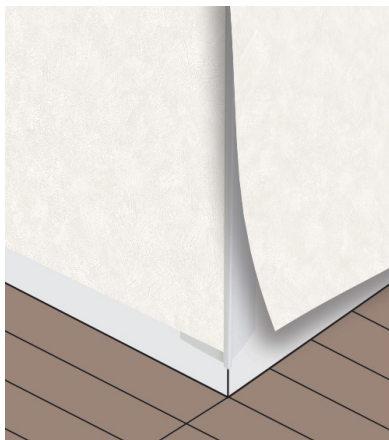
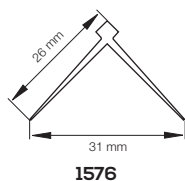



## Skirting with soft lip in top and bottom

Colours:

**5118:** White, Off-white

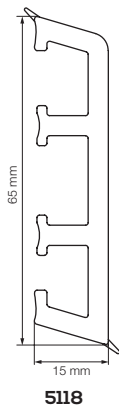

\*

The soft lip that adapts to the wall for a tight seal.



## Skirting Easy and Architrave Easy has a classic profile with bevelled edges

The Easy skirting is mounted on clips, without visible screws and nails. Once installed, it is easy to click the panels on and off when painting, wallpapering or changing floor coverings - without damaging the panel. The moulding can alternatively be nailed or glued in place.

### Skirting & Architrave Easy med og uden clips

**Colours:**

**5106:** White, off-white, anthracite

**5107:** White, off-white

**T2000751:** White



**T2000751**

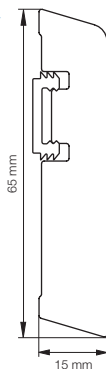

**5106**

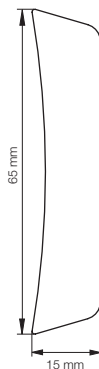

**5107**



# SKIRTINGS

## Skirtings

Colours:

**1724:** White, oak

**5006, 5099:** White

**1521, 1617:** Off-white



**1724**

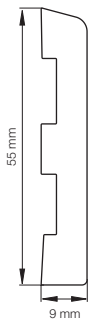

**5006**

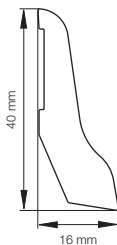

**5099**

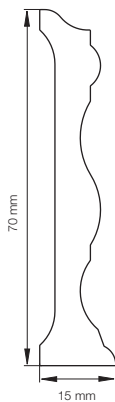

**1521**

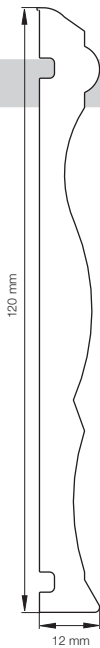

**1617**





# ARCHITRAVES

## Architraves

Colours:

**1306, 7231, 7232:** Off-white

**1722:** White, oak

**5007:** White

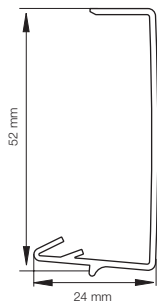

**1306**

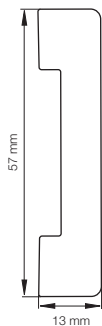

**1722**



**5007**

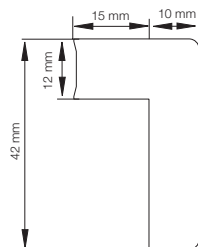

**7231**

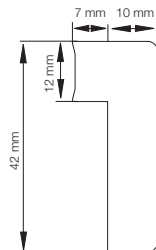

**7232**

PRIMO mouldings make it easy to hide loose wires. We offer a wide range of cable hiding products so you can find a solution that suits your home. Hide wires and cables from your TV, along the floor or wall. Our smart click mouldings for wire and cable hiding always provide an elegant finish.



# CABLE CONCEALMENT

Classic skirting and architraves are mounted on a smart click system, that ensures quick installation without visible screws or nails. If you need to rewire or paint, simply click the skirting on and off. It does not get much easier than this.

## Classic skirting

Colours:

5076: White, off-white, oak

### Mounting kit for 5076:

- 4 x internal corner
- 2 x external corner
- 2 x straight connector
- 2 x end piece (R + L)
- 35 x clips

T2001443: White

T2001444: Off-white

T2000516: Oak

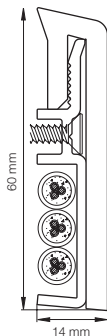

5076

## Classic architrave

Colours:

5082: White, off-white

### Mounting kit for 5082:

- 4 x architrave/skirting coupling
- 4 x mitre joint
- 30 x clips

T2001445: White

T2001446: Off-white

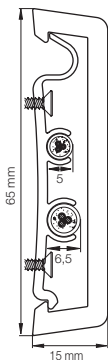

5082

## Cover(it) trim profile & raised beading - self-adhesive



Colours:

4493: Off-white

4544: Off-white



4493

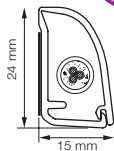

4544

## Cover(it) wall moulding, self-adhesive

Colours:

4560, 4561, 4545: Off-white

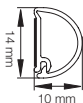

4560

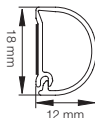

4561



4545

## Cover(it) corner/ceiling moulding self-adhesive

Colours:

4562: Off-white

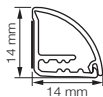

4562



## Cover(it) cable concealer

Colours:

4170: Blank black, alu, white

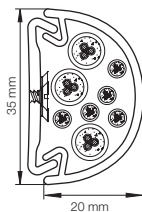

4170

## Cover(it) skirting, self-adhesive

Colours:

4592: Off-white

### Mounting kit for 4592:

- 1 x external corner
- 2 x internal corners
- 1 x straight connector
- 2 x end caps
- 3 x corner connectors

T2001125: Off-white

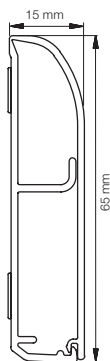

4592



# WIRE-, CABLE - & PIPE CONCEALMENT

## Pipe concealment

Colours:

T3000039: White

T3000027: Beech light



### Mounting parts:

Internal corner: White, beech light

External corner: White, beech light

straight connector: White, beech light

End piece L: White, beech light

End piece R: White, Lys beech

Clips: Purple

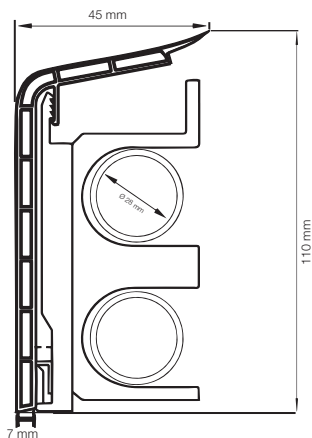

T3000039/T3000027



Internal corner



External corner



Straight connector



Left end piece



Right end piece



Clips

# Pipe Concealment

Colours:

**7081:** Off-white

**7082:** Black

**1292:** Black

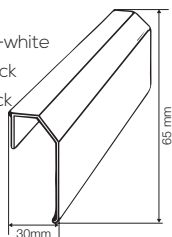

**7081**

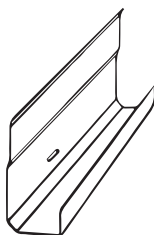

**7082**

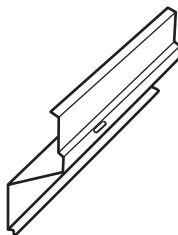

**1292**

**Mounting parts - Off-white:**

**End piece L & R:** 5501-0001-46

**External hjørne:** T4000006

**Internal hjørne:** T4000024

**Straight connector:** T4000025



**5501**



**T4000006**



**T4000024**



**T4000025**

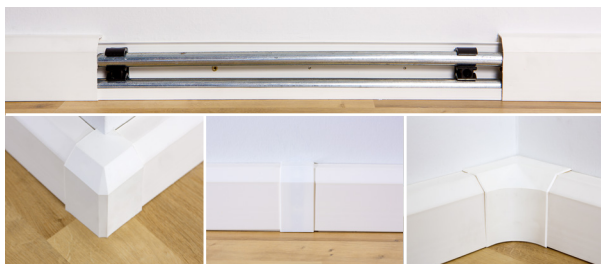

# KITCHEN MOULDINGS

No matter what kind of kitchen you have, you can be sure that PRIMO has a moulding that fits in with the style. Available in a wide range of colours, Primo's kitchen mouldings make it easy to add the finishing touch to the completed job

## Kitchen moulding with mounting profile

**Colours:**

**4818:** Alu

**4907:** Stone, white, alu, beech light, marble, beech, granit, oak, Stone light, Walnut, oak sonoma, Slate, marble light, marble grey, steel.

**5065:** Steel, alu, white, black

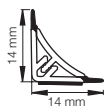

**5065**

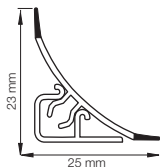

**4907**

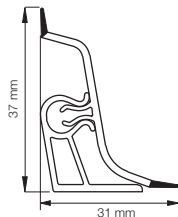

**4818**

### Accessories for 5065:

- 2 x internal corners
- 1 x external corner
- 2 x right end pieces
- 2 x left end pieces



### Accessories for 4907 og 4818:

- 1 x internal corner
- 1 x external corner
- 1 x right end piece
- 1 x left end piece





## U - and H profile

Colours:

4934, 3744: Transparent

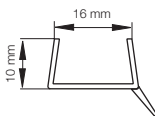

4934



3744

## Universal sealant / sealant profile

Colours:

5095: Alu, white, beige, black

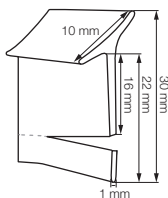

5095

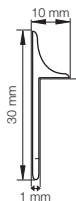

## Connector profile for worktops

Colours:

T3000268, T3000269: Alu



T200268



T200269

# WALL - AND EDGE MOULDINGS

## Wall mouldings

Colours:

**1454, 1331:** White, anthracite, white (self-adhesive)

**5103, 5101, 5100:** White, white (self-adhesive)

**5105, 5104, 5102:** White

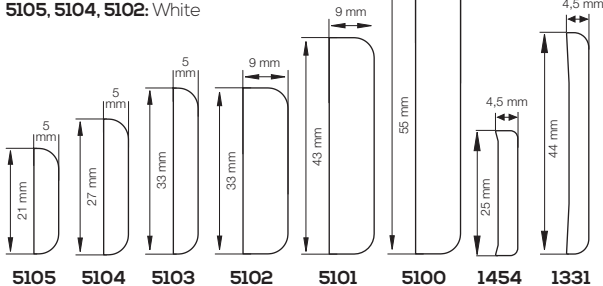

## Edge mouldings

Colours:

**5098:** White, anthracite, white (self-adhesive)

**5097:** White, anthracite

**5096:** White, anthracite white (self-adhesive)

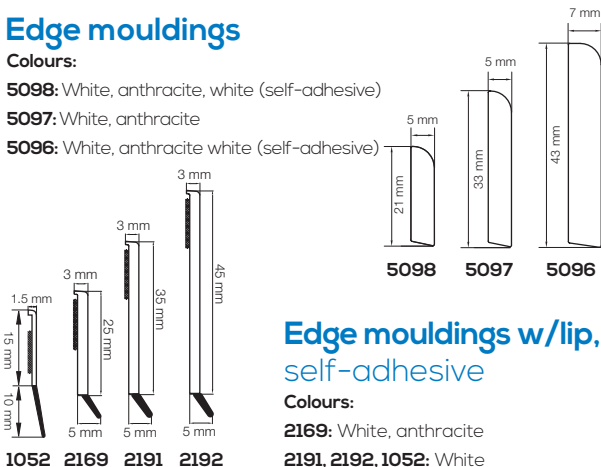

## Edge mouldings w/lip, self-adhesive

Colours:

**2169:** White, anthracite

**2191, 2192, 1052:** White

# GLAZING BEADS

Maintenance-free glazing beads do not absorb water or dry out in the same way as wooden mouldings. This protects you against rot and moisture and gives the window a long service life. The mouldings can be used for single and double glazing as well as openable and fixed windows. An effective solution for window renovation

## Solid glazing beads, base

Colours:

**5068:** White

**5071:** White

**5072:** White

**1859:** White

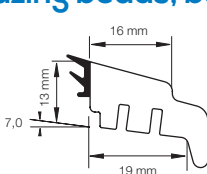

**5068**

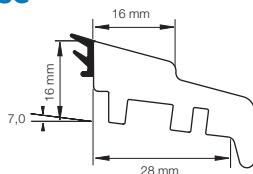

**5071**

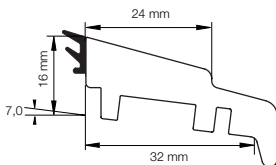

**5072**

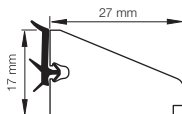

**1859**

Remember to use stainless steel nails  
(T2000290)

## Solid glazing beads, side/top

Colours:

**5064, 5028, 5067, 1927:** White

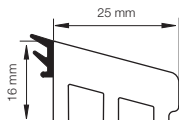

**5064**

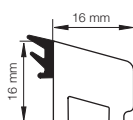

**5028**

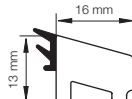

**5067**

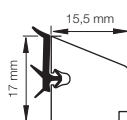

**1927**

## Stainless steel nails

Colours:

T2000290: White



## Alu glazing beads, base

Colours:

T2001664, T2001665: White (alu)

T2001666, T2001667: Alu

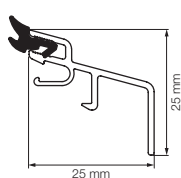

T2001664/  
T2001666

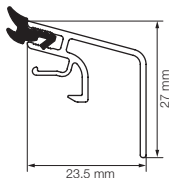

T2001665/  
T2001667



**Accessories** (incl. with purchase)

6 x clips for bevelled seam



Plastic glazing beads are an effective solution for renovating wooden windows

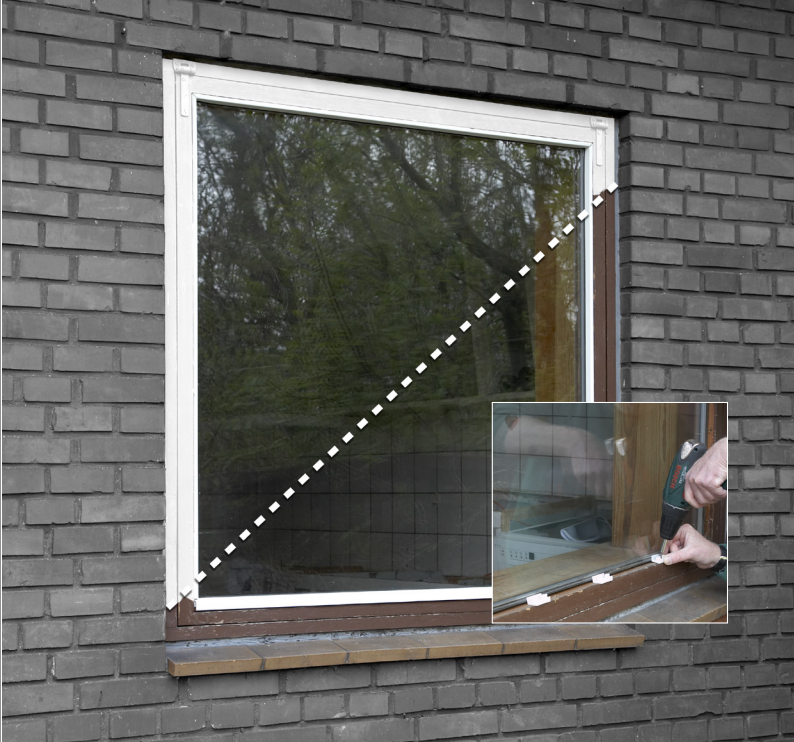

## FiberCore glazing beads

FiberCore glazing beads are both an energy-efficient and durable solution for all exposed areas around windows and doors. PRIMO's FiberCore glazing beads are a combination of natural plant fibres and plastic. This combines nature's strong raw material with the unique and maintenance-free properties of plastic. As a result, FiberCore glazing beads insulate 160 times better than aluminium. FiberCore glazing beads significantly reduce heat loss as they have a U-value of 0.18. The lifespan of the window is also extended as the mouldings do not rot or dry out as a result of the changing seasons. The glazing beads are installed with a unique clip system that ensures quick and easy installation without visible nails or screws.

## FiberCore glazing beads, base for concealed mounting

the showed clips are for bevelled seam

Colours:

4197, 4478: White

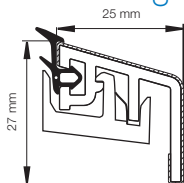

4197

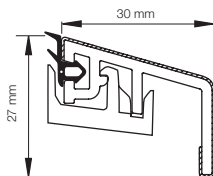

4478

## FiberCore glazing bead, side/top

Colours:

4199: White

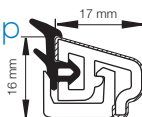

4199

## Clips for glazing beads

Clips for bevelled seam - 20 pcs. per bag

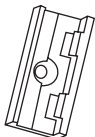

T2000628/  
T2000643

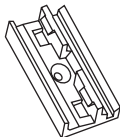

T2000629/  
T2000635



available in lengths  
of 1500, 2500 and  
4000 mm

# KEEP THE HEAT IN ...AND SAVE MONEY!

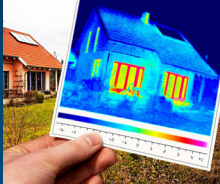

PRIMO gaskets are suitable for all standard window and door types, whether wood, plastic or wood-aluminium.

Made from weatherproof materials for outdoor use, the gaskets are also suitable for a wide range of other applications where optimal sealing is required. The gaskets prevent draughts, chatter, cold and minimise external noise.

## Door- and window gaskets with groove

### Colours:

**0500:** Grey, white

**0575, 0576:** Grey

**0680:** White, beige

**0815:** White, beige, grey, transparent

**0825:** Transparent

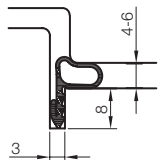

0575

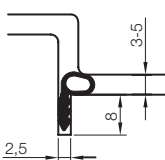

0576

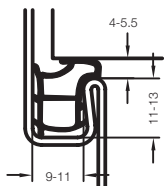

0500

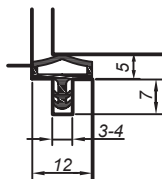

0680

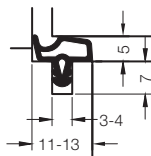

0815

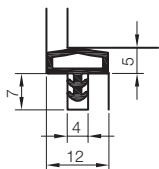

0825

# GASKETS

## Self-adhesive universal gasket + door and window gasket with sealing strip

Colours:

**5113, 5117, T2001544:** White

**5792, 0102:** White, grey, brun, beige

**5924:** White, grey

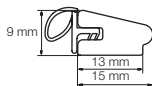

**5113**

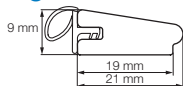

**5117**

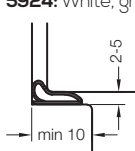

**5792**

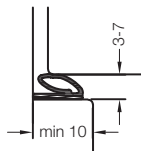

**5924**

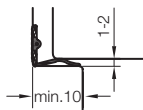

**0102**



**T2001544**

## Gaskets with and without corg

Colours:

**6307:** Black, grey

**5189, 6097, 5765, 5945:** Grey

**5258, 6316, 4050:** Black

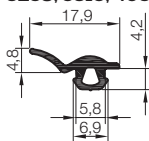

**5189**

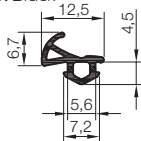

**5258**

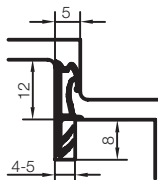

**6307**

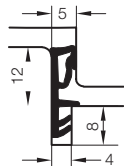

**6097**

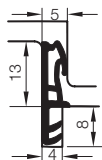

**5765**

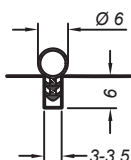

**6316**

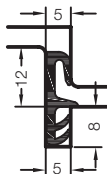

**4050**

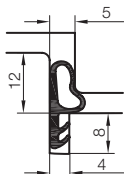

**5945**



## Gaskets for exterior sill + sealing strips and compressed sealing tape

Colours:

**5527:** Black, white

**T3000024:** Black

**T3000025:** White

**T3000221, T3000222:** Grey

**T2001662, T2001663:** Black

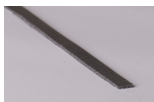

T3000024



T3000025



T3000221



T3000222

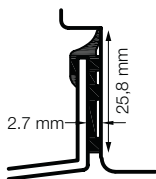

5527



T2001662



T2001663

## Gaskets for glazing beads and seamless installation

Colours:

**5887, 6168:** Grey, black

**6168:** Black

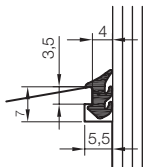

5887

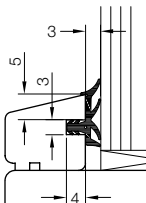

8120

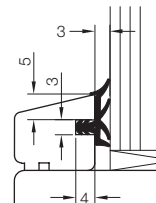

6168

## Clamp gaskets

Colours:

0700, 0703, 0710, 0727,  
0728, 0755, 0775, 0789,  
1345, 1490: Grey

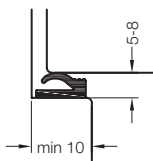

0700

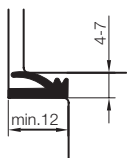

0703

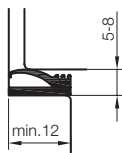

0710

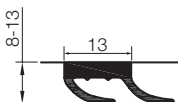

0728

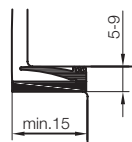

0755

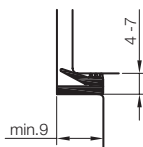

0775

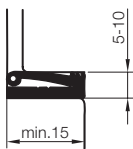

0789

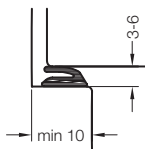

1345

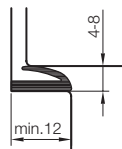

1490

The main cause of faulty gaskets is the daily stresses and years of constantly changing temperatures. Leaky windows and doors result in unpleasant draughts and ever-increasing energy costs. This is precisely why PRIMO developed the new Eco Soft Line series. Due to the excellent oak properties, modern thermoplastic elastomers (TPE) have replaced vulcanised rubber (EPDM) and are always used where the highest quality is required.

### The many benefits of choosing Eco Soft Line are:

- Free from plasticisers    ✓ Easy to clean    ✓ non-ageing    ✓
- Reduces surface noise    ✓ Weldable    ✓ 100% recycable    ✓
- Minimums temperature  $-40^{\circ}$  ✓ Ozone resistant ✓ UV resistant    ✓
- No water absorption    ✓ PVC free    ✓ Weather resistant    ✓

## Eco Soft Line

Colours:

6376,6390: Grey

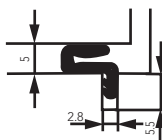
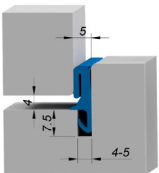
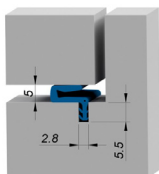

6376

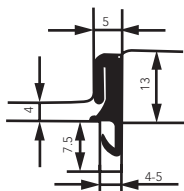

6390

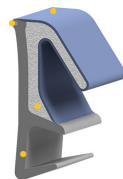
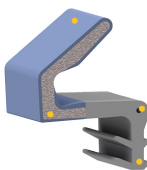

# Accessories for gaskets

## INDROLLERS



### T300031I- for window gaskets

For e.g. 5765, 5945, 6097 og 6307



### T3000310- for silicone gaskets

For soft profiles where pressure needs to be applied to the groove



### T3000312- for door gaskets

For e.g. 0680, 6316, 0815 og 0825

## HPP mitre pliers



T3000301

## Mitre pliers 60-120 degrees



T3000302

## Blades

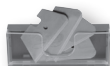

T2000300

Wrong



Right



## SOFT SKIRTINGS

The soft skirtings provide robust and attractive transitions between floor and wall. They are particularly suitable for e.g. high-traffic environments and where good hygiene is a must, as the mouldings are easy to clean.

When welded together, they are well suited for wet rooms, between linoleum floors and walls and as a finishing touch on stairs.



## Soft skirtings, self-adhesive

### Colours:

Grey, Black, off-white



Skirting  
model example  
2 mm



Skirting  
model example  
1,3 mm

	PVC	PVC	NON-PVC
Hight (mm)	40	-	
	50	50	Ask about the size you need
	60	60	
	70	70	
	80	80	
	100	100	



# SOFT ANGLES

Colours:

**0619:** Black, off-white

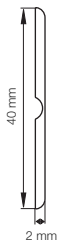

**0619**



## Soft angles, self-adhesive

Colours:

**T3000255:** White

**T3000256:** Black

**T3000257:** Grey

**T3000258:** Beige

**T3000259:** Oak

**T3000260:** White

**T3000261:** Black

**T3000262:** Grey

**T3000263:** Beige

**T3000264:** Oak



**T3000255**  
**T3000256**  
**T3000257**  
**T3000258**  
**T3000259**

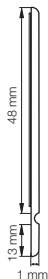

**T3000260**  
**T3000261**  
**T3000262**  
**T3000263**  
**T3000264**



# VARIOUS

## Stair nosings

Colours:

**0600, 0546, 0647, 0688:** Black

**0509:** Black, grey

**4580:** Black (inserts: black and

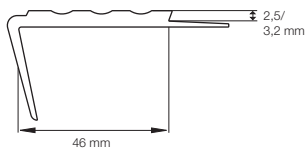

**0600**

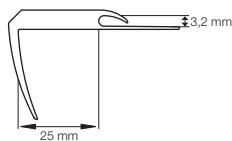

**0546**

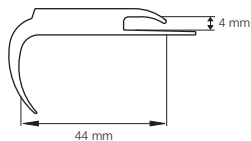

**0647**

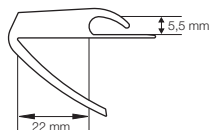

**0688**

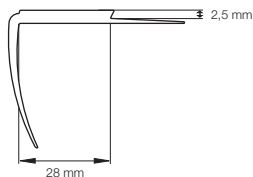

**0509**

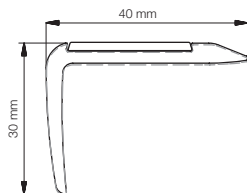

**4580**



## Handrail

Colours:

**0603:** Black

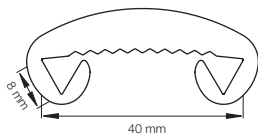

**0603**



## Vinyl ending and string cover

Colours:

**4472:** Grey

**0578:** Black

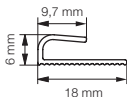

**4472**

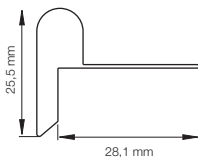

**0578**

## Edge profiles

Colours:

**4650:** Off-white

**0560, 0807:** Transparent

**0807:** White

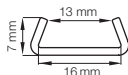

**4650**



**0560**



**0807**

## Sliding glass beading

Colours:

**0566, 0567:** Grey

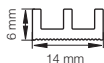

**0566**

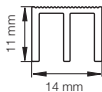

**0567**

## Nylon twister

Colours:

**T2000274:** White



**T2000274**

# DOOR AND WALL PROTECTION

Colours:

**4494:** Grey

**4076, 4304:** White

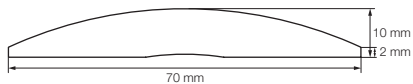

**4494**

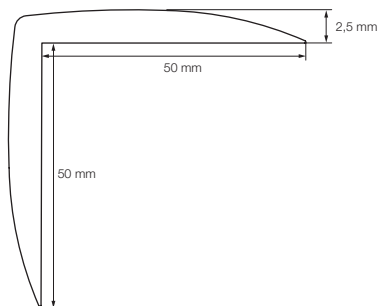

**4076**



**4304**



# FACADES

## Light covers and casings

Colours:

T2000524, 2114, 2837, 5008, 2598: White

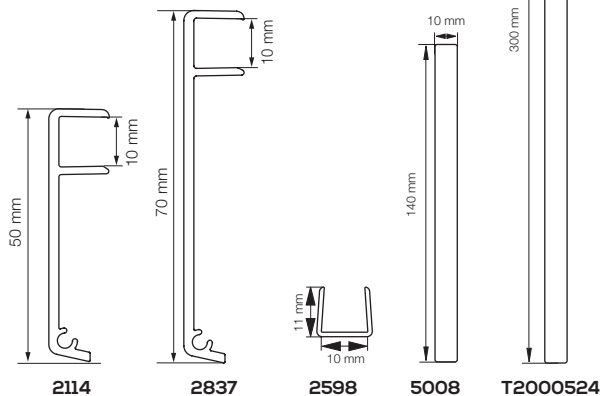

# INVENTORY

## Worktop edging strips

Colours:

**0526,0528:** Grey

**0529:** Black

**0730:** Black, grey,  
white

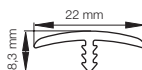

**0526**

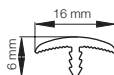

**0528**



**0529**

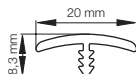

**0730**

## Assembly tongue and edge protection trim

Colours:

**1402:** Black

**1244:** Grey

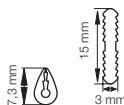

**1244**

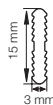

**1402**

The products are typically used where the desire for maintenance-free and easy-to-clean surfaces are highly prioritised

PRIMO's many plastic profiles for use in construction are developed in close collaboration with industry professionals.

The products can be customised and installed with ordinary hand tools and are as easy to work with as other types of building materials.

At the same time, the durability and maintenance benefits of plastic are fully preserved.



## PLASTIC - a good solution

Plastic is everywhere in our daily lives, and for good reason. Plastic has properties that make it extremely durable and it has the unique advantage that it can be recycled - up to several times.

Unlike wood, plastic doesn't need to be painted or treated, and at the end of its lifetime, it can live on - where other materials end up in the incinerator!

## Personalised service

Even the most comprehensive catalogue or websites can't answer every question you might have.

So if you didn't find the information that you needed, customer service can always be contacted at:

**Phone: +45 76 98 33 14**

**E-mail: [stdsalg@primo.dk](mailto:stdsalg@primo.dk)**

**On our webpage [www.primolister.com](http://www.primolister.com) you can always find the latest and updated information**

**PRIMO** 

PRIMO DANMARK A/S  
Jernbanegade 11  
DK-6862 Tistrup  
Tlf. +45 76 98 33 14  
[www.primolister.com](http://www.primolister.com)